

IP 40

Ürün Kodu Product Code	Güç Power (W)	Işık Akışı Light Flux (lm)	Işık Kaynağı Light Source	Renk Sıcaklığı Color Temp.	Boyutlar Dimension (W/L/H)	Kesim Ölçüsü Cut-Out Dimension (W/L/Hmm)	Ağırlık Weight (Kg)
VK100 109LED	5	350	GU10	2700-3000K	103X103X100	90X90	-

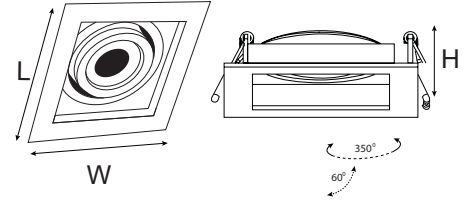
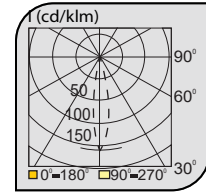

IP40

Ürün Kodu Product Code	Güç Power (W)	Işık Akışı Light Flux (lm)	Işık Kaynağı Light Source	Renk Sıcaklığı Color Temp.	Boyutlar Dimension (W/L/H)	Kesim Ölçüsü Cut-Out Dimension (W/L/Hmm)	Ağırlık Weight (Kg)
VK100 112LED	5	350	GU10	2700-3000K	115X115X90	95X95X90	-

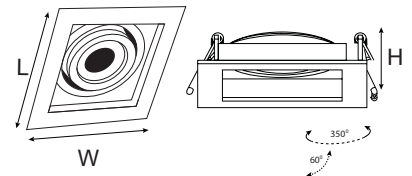
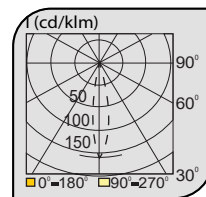
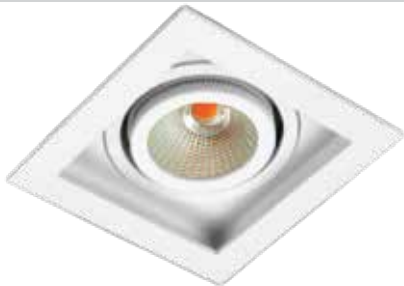

IP40

Ürün Kodu Product Code	Güç Power (W)	Işık Akışı Light Flux (lm)	Işık Kaynağı Light Source	Renk Sıcaklığı Color Temp.	Boyutlar Dimension (W/L/H)	Kesim Ölçüsü Cut-Out Dimension (W/L/Hmm)	Ağırlık Weight (Kg)
VK100 211LED	10	1100	COB LED	2700-3000K	115X115X80	95X95X80	-

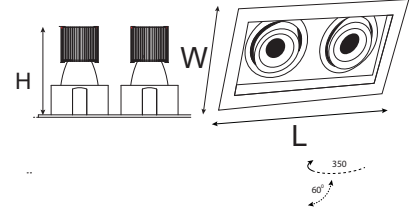
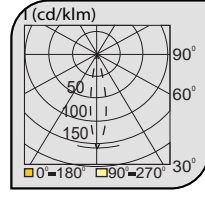

IP 40

Ürün Kodu Product Code	Güç Power (W)	Işık Akışı Light Flux (lm)	Işık Kaynağı Light Source	Renk Sıcaklığı Color Temp.	Boyutlar Dimension (W/L/H)	Kesim Ölçüsü Cut-Out Dimension (W/L/Hmm)	Ağırlık Weight (Kg)
VK100 212LED	2X5	700	GU10	2700-3000K	115X230X90	95X210X90	-

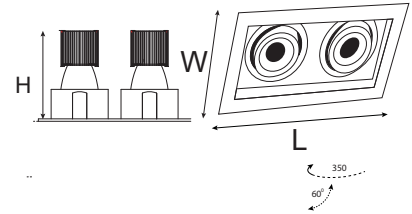
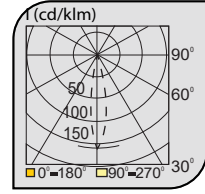

IP 40

Ürün Kodu Product Code	Güç Power (W)	Işık Akışı Light Flux (lm)	Işık Kaynağı Light Source	Renk Sıcaklığı Color Temp.	Boyutlar Dimension (W/L/H)	Kesim Ölçüsü Cut-Out Dimension (W/L/Hmm)	Ağırlık Weight (Kg)
VK100 210LED	2X10	2000	COB LED	3000-4000K	115X230X80	95X210	-

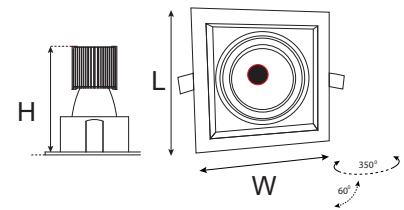
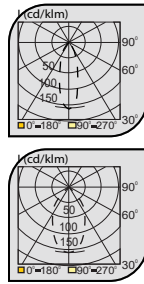

Ürün Kodu Product Code	Güç Power (W)	Işık Akışı Light Flux (lm)	Işık Kaynağı Light Source	Renk Sıcaklığı Color Temp.	Boyutlar Dimension (W/L/H)	Kesim Ölçüsü Cut-Out Dimension (W/L/Hmm)	Ağırlık Weight (Kg)
VK066 201LED	20	2000	COB LED	3000-4000K	195X195X150	170X170X150	-



IP 40

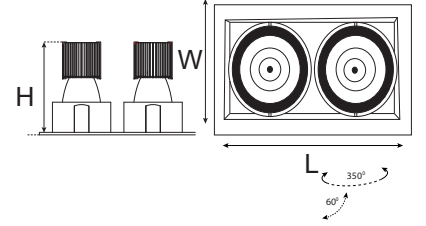
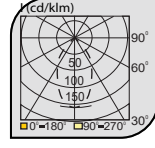
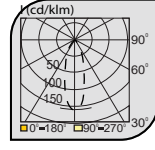

Ürün Kodu Product Code	Güç Power (W)	Işık Akışı Light Flux (lm)	Işık Kaynağı Light Source	Renk Sıcaklığı Color Temp.	Boyutlar Dimension (W/L/H)	Kesim Ölçüsü Cut-Out Dimension (W/L/Hmm)	Ağırlık Weight (Kg)
VK066 202LED	2X20	4000	COB LED	3000-4000K	190X350X150	170X320X150	-

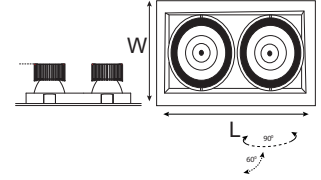
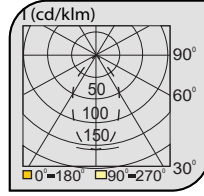

Ürün Kodu Product Code	Güç Power (W)	Işık Akışı Light Flux (lm)	Işık Kaynağı Light Source	Renk Sıcaklığı Color Temp.	Boyutlar Dimension (W/L/H)	Kesim Ölçüsü Cut-Out Dimension (W/L/Hmm)	Ağırlık Weight (Kg)
VK066 216LED	2X16	3200	COB LED	2700-3000-4000K	185X335X85	170X315X85	-



IP40

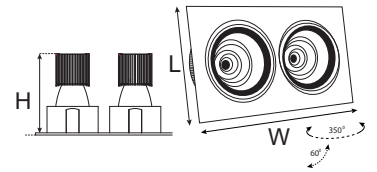
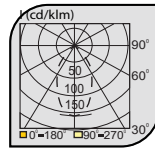
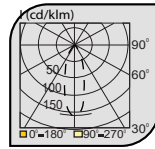

Ürün Kodu Product Code	Güç Power (W)	Işık Akışı Light Flux (lm)	Işık Kaynağı Light Source	Renk Sıcaklığı Color Temp.	Boyutlar Dimension (W/L/H)	Kesim Ölçüsü Cut-Out Dimension (W/L/Hmm)	Ağırlık Weight (Kg)
VK066 220LED	2X20	4000	COB LED	3000-4000K	190X340X150	170X320X150	-



IP 40

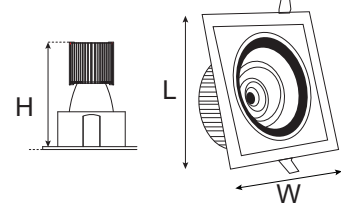
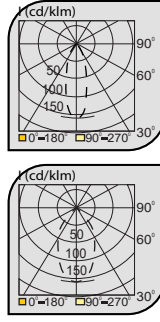

Ürün Kodu Product Code	Güç Power (W)	Işık Akışı Light Flux (lm)	Işık Kaynağı Light Source	Renk Sıcaklığı Color Temp.	Boyutlar Dimension (W/L/H)	Kesim Ölçüsü Cut-Out Dimension (W/L/Hmm)	Ağırlık Weight (Kg)
VK066 203LED	30	3000	COB LED	3000-4000K	190X190X150	170X170X150	-



IP 40

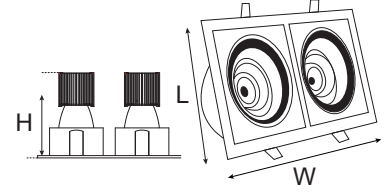
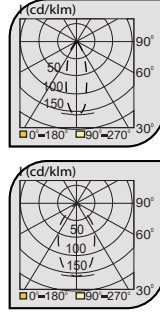

Ürün Kodu Product Code	Güç Power (W)	Işık Akışı Light Flux (lm)	Işık Kaynağı Light Source	Renk Sıcaklığı Color Temp.	Boyutlar Dimension (W/L/H)	Kesim Ölçüsü Cut-Out Dimension (W/L/Hmm)	Ağırlık Weight (Kg)
VK066 204LED	2X30	6000	COB LED	3000-4000K	190X340X150	170X320X150	-

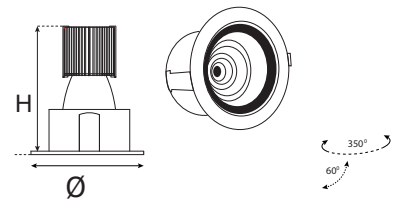
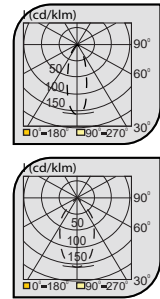

Ürün Kodu Product Code	Güç Power (W)	Işık Akışı Light Flux (lm)	Işık Kaynağı Light Source	Renk Sıcaklığı Color Temp.	Boyutlar Dimension (Ø/H)	Kesim Ölçüsü Cut-Out Dimension (Ø/Hmm)	Ağırlık Weight (Kg)
VK055 120LED	20	2000	COB LED	3000-4000K	190X150	175X150	
VK055 130LED	30	3000	COB LED	3000-4000K	190X150	175X150	



IP40

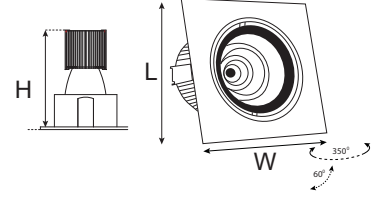
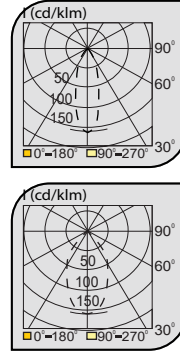

Ürün Kodu Product Code	Güç Power (W)	Işık Akışı Light Flux (lm)	Işık Kaynağı Light Source	Renk Sıcaklığı Color Temp.	Boyutlar Dimension (W/L/H)	Kesim Ölçüsü Cut-Out Dimension (W/L/Hmm)	Ağırlık Weight (Kg)
VK066 120LED	20	2000	COB LED	3000-4000K	190X190X150	170X170X150	-



IP 40

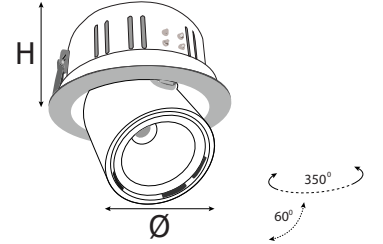
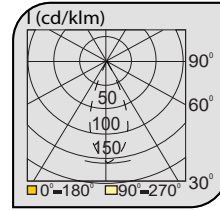

Ürün Kodu Product Code	Güç Power (W)	Işık Akışı Light Flux (lm)	Işık Kaynağı Light Source	Renk Sıcaklığı Color Temp.	Boyutlar Dimension (Ø/H)	Kesim Ölçüsü Cut-Out Dimension (Ø/Hmm)	Ağırlık Weight (Kg)
VK065 201LED SLYG	25	3500	COB LED	3000-4000K	185X90	165X90	-



IP40

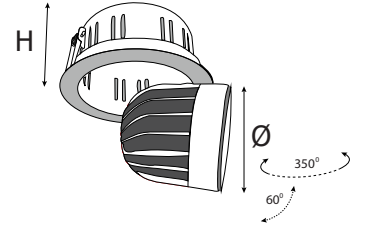
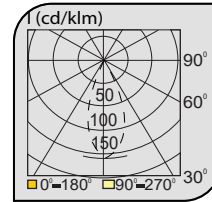

Ürün Kodu Product Code	Güç Power (W)	Işık Akışı Light Flux (lm)	Işık Kaynağı Light Source	Renk Sıcaklığı Color Temp.	Boyutlar Dimension (Ø/H)	Kesim Ölçüsü Cut-Out Dimension (Ø/Hmm)	Ağırlık Weight (Kg)
VK066 201LED SLYG	25	3500	COB LED	3000-4000K	185X90	165X90	-



IP40

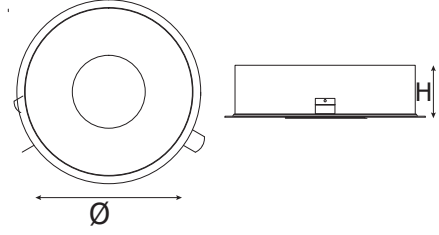
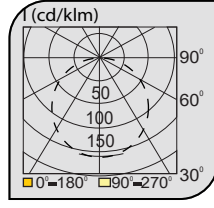

Ürün Kodu Product Code	Güç Power (W)	Işık Akışı Light Flux (İm)	Işık Kaynağı Light Source	Renk Sıcaklığı Color Temp.	Boyutlar Dimension (Ø/H)	Kesim Ölçüsü Cut-Out Dimension (Ø/Hmm)	Ağırlık Weight (Kg)
VK126 155LED	23	2300	SMD LED	3000-4000K	400X100	380X100	-



IP 40

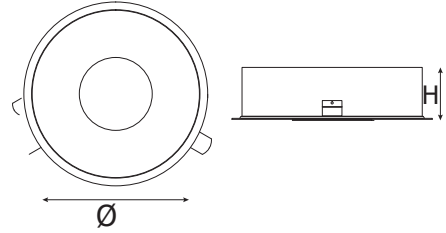
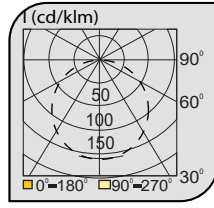

Ürün Kodu Product Code	Güç Power (W)	Işık Akışı Light Flux (İm)	Işık Kaynağı Light Source	Renk Sıcaklığı Color Temp.	Boyutlar Dimension (Ø/H)	Kesim Ölçüsü Cut-Out Dimension (Ø/Hmm)	Ağırlık Weight (Kg)
VK119 140LED	23	2300	SMD LED	3000-4000K	400X100	380X100	-



IP 40

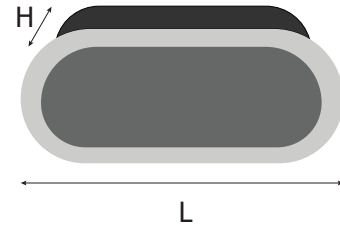

Ürün Kodu Product Code	Güç Power (W)	Işık Akışı Light Flux (İm)	Işık Kaynağı Light Source	Renk Sıcaklığı Color Temp.	Boyutlar Dimension (W/L/H)	Kesim Ölçüsü Cut-Out Dimension (W/L/Hmm)	Ağırlık Weight (Kg)
VK016 254LED	45	4500	SMD LED	3000-4000K	150X1000X100	-	-

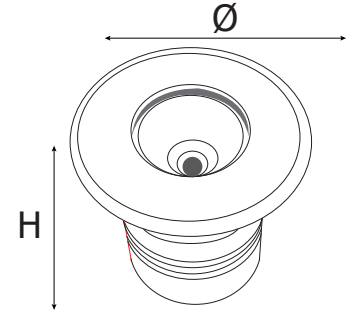
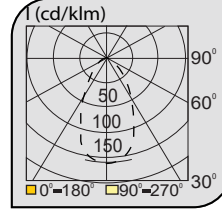

IP 40

Ürün Kodu Product Code	Güç Power (W)	Işık Akışı Light Flux (lm)	Işık Kaynağı Light Source	Renk Sıcaklığı Color Temp.	Boyutlar Dimension (Ø/Hmm)	Kesim Ölçüsü Cut-Out Dimension (Ø/Hmm)	Ağırlık Weight (Kg)
VK019 302LED	10	1100	COB LED	3000-4000K	100X120	70X120	-

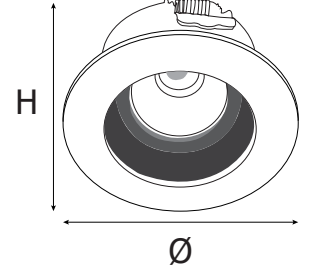
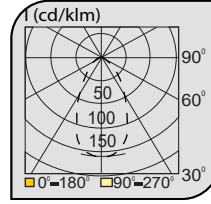

IP40

Ürün Kodu Product Code	Güç Power (W)	Işık Akışı Light Flux (lm)	Işık Kaynağı Light Source	Renk Sıcaklığı Color Temp.	Boyutlar Dimension (Ø/Hmm)	Kesim Ölçüsü Cut-Out Dimension (Ø/Hmm)	Ağırlık Weight (Kg)
VK100 151LED	10	1100	COB LED	3000-4000K	95X75	85X75	-

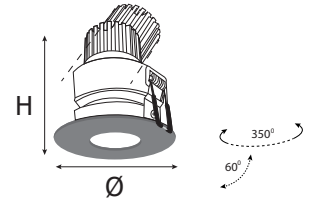
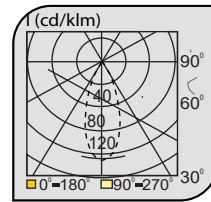

IP40

Ürün Kodu Product Code	Güç Power (W)	Işık Akışı Light Flux (lm)	Işık Kaynağı Light Source	Renk Sıcaklığı Color Temp.	Boyutlar Dimension (Ø/H mm)	Kesim Ölçüsü Cut-Out Dimension (Ø/H mm)	Ağırlık Weight (Kg)
VK100 151LED1	10	1100	COB LED	3000-4000K	92X94	85X94	-

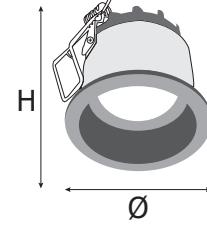
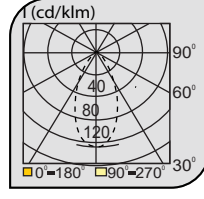

IP 40

Ürün Kodu Product Code	Güç Power (W)	Işık Akışı Light Flux (lm)	Işık Kaynağı Light Source	Renk Sıcaklığı Color Temp.	Boyutlar Dimension (Ø/H mm)	Kesim Ölçüsü Cut-Out Dimension (Ø/H mm)	Ağırlık Weight (Kg)
VK018 101LED	10	1100	COB LED	3000-4000K	72X76	65X76	

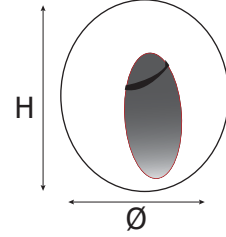
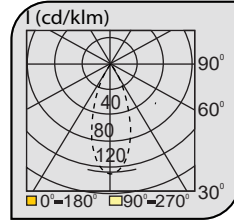
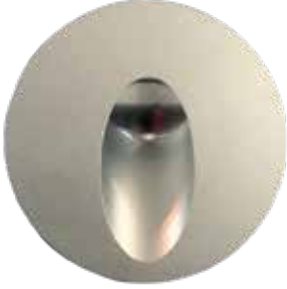

IP 44

Ürün Kodu Product Code	Güç Power (W)	Işık Akışı Light Flux (lm)	Işık Kaynağı Light Source	Renk Sıcaklığı Color Temp.	Boyutlar Dimension (Ø/H mm)	Kesim Ölçüsü Cut-Out Dimension (Ø/H mm)	Ağırlık Weight (Kg)
VK019 306LED	1	160	POWER LED	3000-4000K	55X75	45X75	-

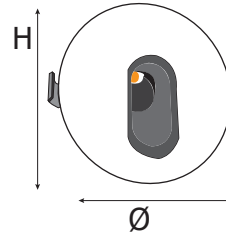
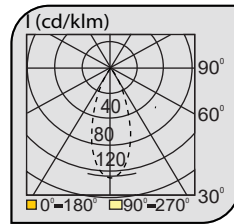

IP 20

Ürün Kodu Product Code	Güç Power (W)	Işık Akışı Light Flux (lm)	Işık Kaynağı Light Source	Renk Sıcaklığı Color Temp.	Boyutlar Dimension (Ø/H mm)	Kesim Ölçüsü Cut-Out Dimension (Ø/H mm)	Ağırlık Weight (Kg)
VK018 200LED	1	160	POWER LED	3000-4000K	45X46	40X46	

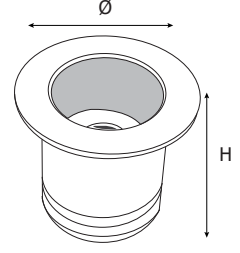

Ürün Kodu Product Code	Güç Power (W)	Işık Akışı Light Flux (lm)	Işık Kaynağı Light Source	Renk Sıcaklığı Color Temp.	Boyutlar Dimension (Ø/H)	Kesim Ölçüsü Cut-out Dimension (Ø/hmm)	Ağırlık Weight (Kg)
VK018 101LED	1,5	150	POWER LED	3000-4000-6500K	55X45	40X45	-
							-
							-

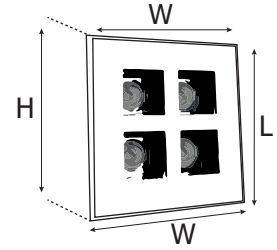
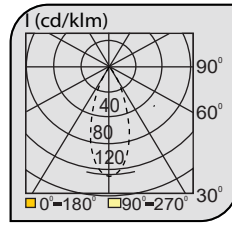

IP44

Ürün Kodu Product Code	Güç Power (W)	Işık Akışı Light Flux (lm)	Işık Kaynağı Light Source	Renk Sıcaklığı Color Temp.	Boyutlar Dimension (W/L/H mm)	Kesim Ölçüsü Cut-Out Dimension (W/L/H mm)	Ağırlık Weight (Kg)
VK100 106LED	16	2000	POWER LED	3000-4000K	110X110X75	100X100X75	-
							-
							-

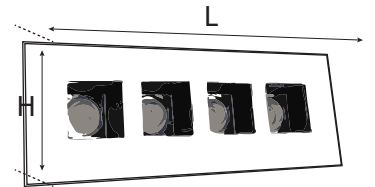
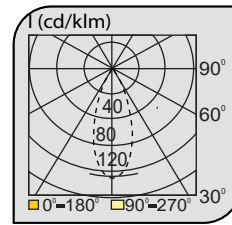

IP20

Ürün Kodu Product Code	Güç Power (W)	Işık Akışı Light Flux (lm)	Işık Kaynağı Light Source	Renk Sıcaklığı Color Temp.	Boyutlar Dimension (W/L/H mm)	Kesim Ölçüsü Cut-Out Dimension (W/L/H mm)	Ağırlık Weight (Kg)
VK100 107LED	16	2000	POWER LED	3000-4000K	70X190X75	55X185X75	-
							-
							-

