

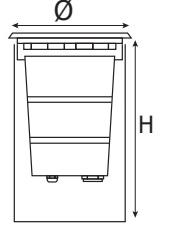

IP 65

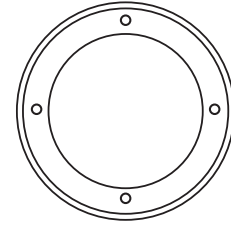

Ürün Kodu Product Code	Güç Power (W)	Işık Akışı Light Flux (lm)	Işık Kaynağı Light Source	Renk Sıcaklığı Color Temp.	Boyutlar Dimension (Ø/H)	Kesim Ölçüsü Cut-Out Dimension (Ø/Hmm)	Ağırlık Weight (Kg)
VK019 318LED	18	2200	POWER LED	3000-4000K	220X200	175X200	-



IP 65

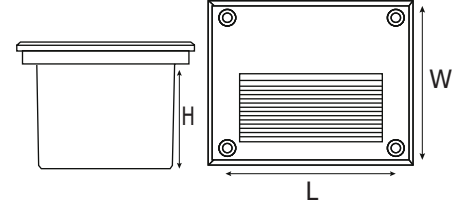
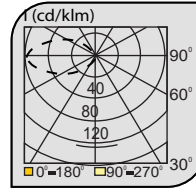

Ürün Kodu Product Code	Güç Power (W)	Işık Akışı Light Flux (lm)	Işık Kaynağı Light Source	Renk Sıcaklığı Color Temp.	Boyutlar Dimension (W/L/H)	Kesim Ölçüsü Cut-Out Dimension (W/L/Hmm)	Ağırlık Weight (Kg)
VK170 050LED	3	300	SMD LED	3000-4000K	110X110X50	90X90X50	-



IP 65

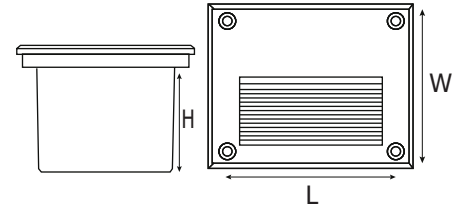
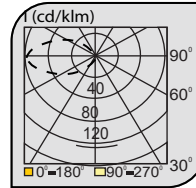

Ürün Kodu Product Code	Güç Power (W)	Işık Akışı Light Flux (lm)	Işık Kaynağı Light Source	Renk Sıcaklığı Color Temp.	Boyutlar Dimension (W/L/H)	Kesim Ölçüsü Cut-Out Dimension (W/Lmm)	Ağırlık Weight (Kg)
VK170 051LED	12	1200	SMD LED	3000-4000K	110X260X75	90X240X75	-



### IP 54

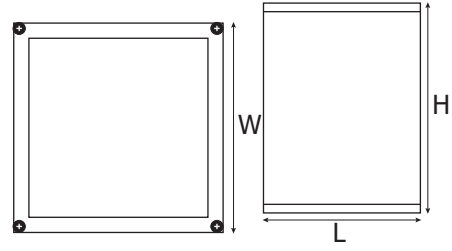

Ürün Kodu Product Code	Güç Power (W)	Işık Akışı Light Flux (lm)	Işık Kaynağı Light Source	Renk Sıcaklığı Color Temp.	Boyutlar Dimension (W/L/H)	Kesim Ölçüsü Cut-Out Dimension (W/Lmm)	Ağırlık Weight (Kg)
VK170 150LED	11	950	PAR 30 LED	3000-6500K	118X118X150	-	-



### IP 65

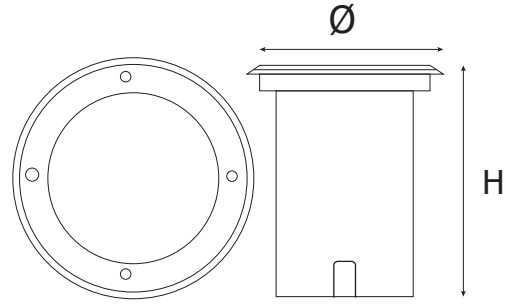

Ürün Kodu Product Code	Güç Power (W)	Işık Akışı Light Flux (lm)	Işık Kaynağı Light Source	Renk Sıcaklığı Color Temp.	Boyutlar Dimension (Ø/H)	Kesim Ölçüsü Cut-Out Dimension (Ø/Hmm)	Ağırlık Weight (Kg)
VK019 307LED	7	500	COB LED	3000-4000K	110X149	100X149	-



### IP 65

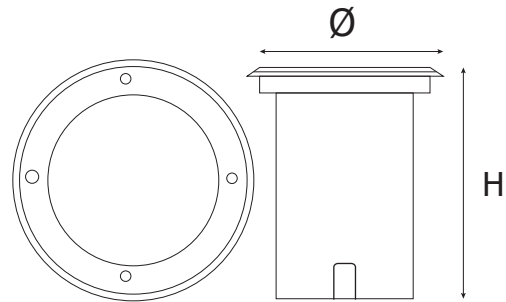

Ürün Kodu Product Code	Güç Power (W)	Işık Akışı Light Flux (lm)	Işık Kaynağı Light Source	Renk Sıcaklığı Color Temp.	Boyutlar Dimension (Ø/H)	Kesim Ölçüsü Cut-Out Dimension (Ø/Hmm)	Ağırlık Weight (Kg)
VK019 308LED	5	350	GU10	2700-3000K	110X75	85X75	-



IP 65

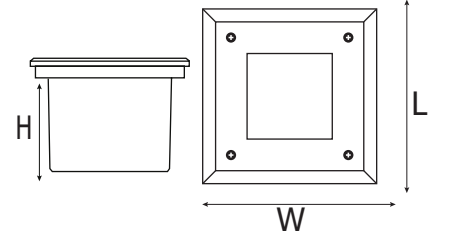

Ürün Kodu Product Code	Güç Power (W)	Işık Akışı Light Flux (lm)	Işık Kaynağı Light Source	Renk Sıcaklığı Color Temp.	Boyutlar Dimension (W/L/H)	Kesim Ölçüsü Cut-Out Dimension (W/L/Hmm)	Ağırlık Weight (Kg)
VK019 305LED	5	350	GU10	2700-3000K	140X140X130	110X110X130	-



IP 65

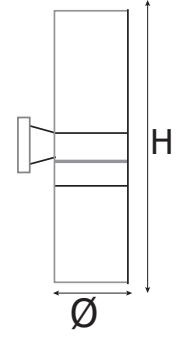
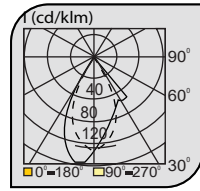

Ürün Kodu Product Code	Güç Power (W)	Işık Akışı Light Flux (lm)	Işık Kaynağı Light Source	Renk Sıcaklığı Color Temp.	Boyutlar Dimension (Ø/H)	Kesim Ölçüsü Cut-Out Dimension (Ø/Hmm)	Ağırlık Weight (Kg)
VK170 250LED	2X11	1900	PAR 30 LED	3000-6500K	108X270	-	-



IP 54

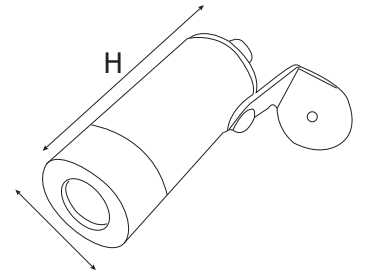

Ürün Kodu Product Code	Güç Power (W)	Işık Akışı Light Flux (lm)	Işık Kaynağı Light Source	Renk Sıcaklığı Color Temp.	Boyutlar Dimension (Ø/H)	Kesim Ölçüsü Cut-Out Dimension (Ø/Hmm)	Ağırlık Weight (Kg)
VK600 040LED	3	250	SMD LED	3000-4000K	37X110	-	-

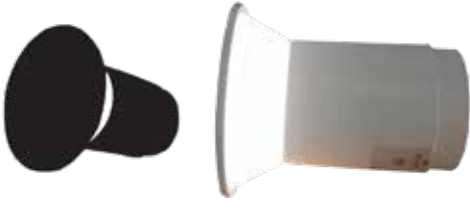

IP 54

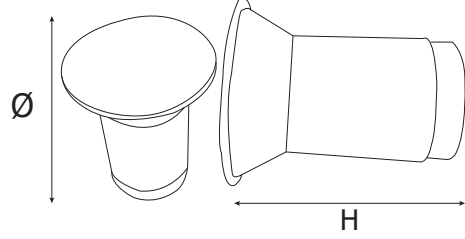

Ürün Kodu Product Code	Güç Power (W)	Işık Akışı Light Flux (lm)	Işık Kaynağı Light Source	Renk Sıcaklığı Color Temp.	Boyutlar Dimension (Ø/H)	Kesim Ölçüsü Cut-Out Dimension (Ø/Hmm)	Ağırlık Weight (Kg)
VK601 050LED	4	410	SMD LED	3000-4000K	100X120	-	-



IP 65

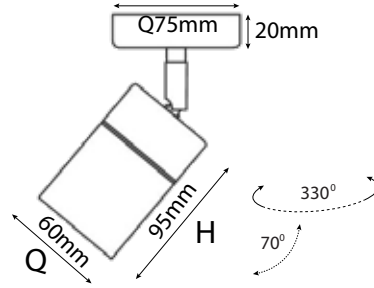

Ürün Kodu Product Code	Güç Power (W)	Işık Akışı Light Flux (lm)	Işık Kaynağı Light Source	Renk Sıcaklığı Color Temp.	Boyutlar Dimension (Q/H/Lmm)	Çalışma Gerilimi Operating Voltage	Ağırlık Weight (Kg)
VK019 107LED	7	650	COB LED	3000K	60X95	24V DC	-



IP 54

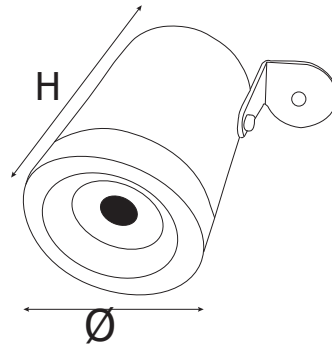

Ürün Kodu Product Code	Güç Power (W)	Işık Akışı Light Flux (lm)	Işık Kaynağı Light Source	Renk Sıcaklığı Color Temp.	Boyutlar Dimension (Ø/H)	Kesim Ölçüsü Cut-Out Dimension (Ø/Hmm)	Ağırlık Weight (Kg)
VK600 060LED	5	450	GU10	3000-4000K	62X115	-	-



IP 54

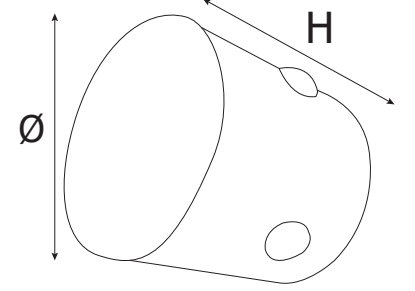

Ürün Kodu Product Code	Güç Power (W)	Işık Akışı Light Flux (lm)	Işık Kaynağı Light Source	Renk Sıcaklığı Color Temp.	Boyutlar Dimension (Ø/H)	Kesim Ölçüsü Cut-Out Dimension (Ø/Hmm)	Ağırlık Weight (Kg)
VK601 100LED	5	450	POWER LED	3000-4000K	100X100	-	-



IP 54

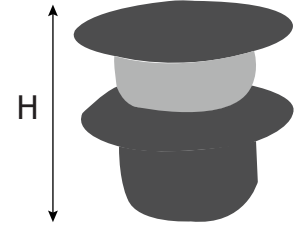

Ürün Kodu Product Code	Güç Power (W)	Işık Akışı Light Flux (lm)	Işık Kaynağı Light Source	Renk Sıcaklığı Color Temp.	Boyutlar Dimension (Ø/H mm)	Kesim Ölçüsü Cut-Out Dimension (Ø/H mm)	Ağırlık Weight (Kg)
VK601 051LED	1,2	150	POWER LED	3000-4000K	58X62	57X62	-



IP 54

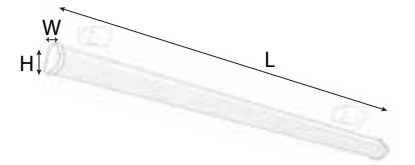
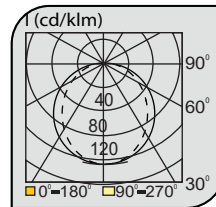

Ürün Kodu Product Code	Güç Power (W)	Işık Akışı Light Flux (lm)	Işık Kaynağı Light Source	Renk Sıcaklığı Color Temp.	Boyutlar Dimension (W/L/Hmm)	Kesim Ölçüsü Cut-Out Dimension (W/L/Hmm)	Ağırlık Weight (Kg)
VK042 120LED	40	3900	SMD LED	3000-4000K	120X1200X130	-	-

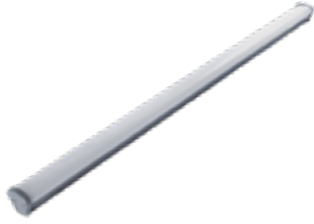

IP 65

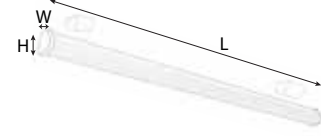
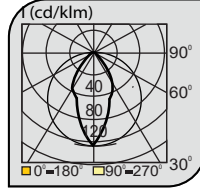

Ürün Kodu Product Code	Güç Power (W)	Işık Akışı Light Flux (lm)	Işık Kaynağı Light Source	Renk Sıcaklığı Color Temp.	Boyutlar Dimension (W/L/H)	Kesim Ölçüsü Cut-Out Dimension (W/L/Hmm)	Ağırlık Weight (Kg)
VK041 120LED	35	3850	SMD LED	3000-4000-6500K	75x1200x85	-	-



IP 65

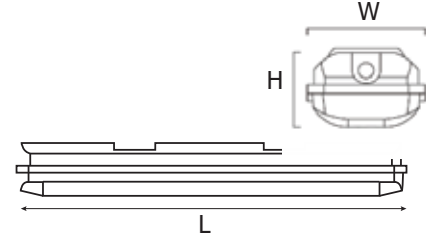
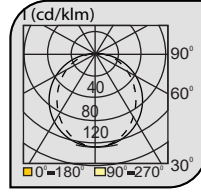

Ürün Kodu Product Code	Güç Power (W)	Işık Akışı Light Flux (lm)	Işık Kaynağı Light Source	Renk Sıcaklığı Color Temp.	Boyutlar Dimension (W/L/H)	Kesim Ölçüsü Cut-Out Dimension (W/L/Hmm)	Ağırlık Weight (Kg)
VK041 118LED	11	1300	SMD LED	3000-4000-6500K	94X676X95	-	-
VK041 136LED	20	2650	SMD LED	3000-4000-6500K	94X1283X95	-	-
VK041 218LED	22	2650	SMD LED	3000-4000-6500K	146X676X95	-	-
VK041 236LED	40	5300	SMD LED	3000-4000-6500K	146X1283X95	-	-

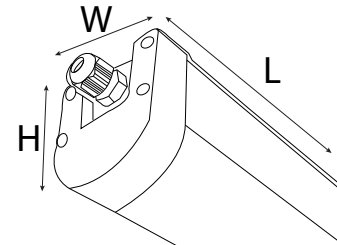
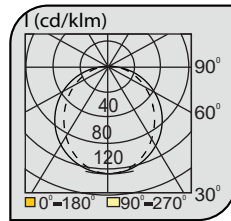

Ürün Kodu Product Code	Güç Power (W)	Işık Akışı Light Flux (lm)	Işık Kaynağı Light Source	Renk Sıcaklığı Color Temp.	Boyutlar Dimension (W/L/H)	Kesim Ölçüsü Cut-Out Dimension (W/L/Hmm)	Ağırlık Weight (Kg)
VK042 118LED	15	2200	SMD LED	3000-4000-6500K	56X580X66	-	-
VK042 136LED	30	4200	SMD LED	3000-4000-6500K	56X1214X66	-	-
VK042 218LED	30	4200	SMD LED	3000-4000-6500K	56X580X66	-	-
VK042 236LED	60	8400	SMD LED	3000-4000-6500K	56X1214X66	-	-

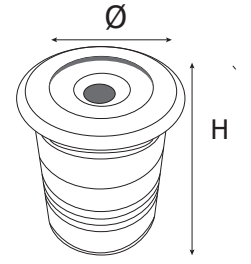
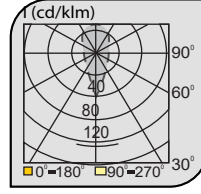

**IP 65**

Ürün Kodu Product Code	Güç Power (W)	Işık Akışı Light Flux (lm)	Işık Kaynağı Light Source	Renk Sıcaklığı Color Temp.	Boyutlar Dimension (Ø/Hmm)	Kesim Ölçüsü Cut-Out Dimension (Ø/Hmm)	Ağırlık Weight (Kg)
VK019 304LED	5	350	GU10	3000-4000K	80X110	67X110	-

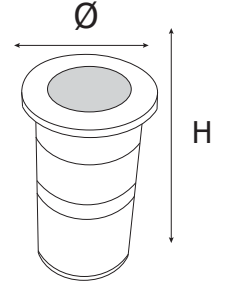
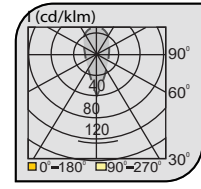

**IP 65**

Ürün Kodu Product Code	Güç Power (W)	Işık Akışı Light Flux (lm)	Işık Kaynağı Light Source	Renk Sıcaklığı Color Temp.	Boyutlar Dimension (Ø/Hmm)	Kesim Ölçüsü Cut-Out Dimension (Ø/Hmm)	Ağırlık Weight (Kg)
VK019 103LED	1,2	150	POWER LED	3000-4000K	50X90	40X90	-

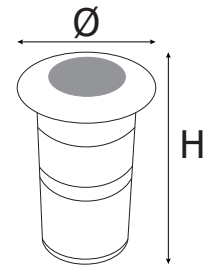
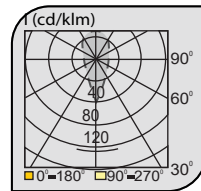

**IP 65**

Ürün Kodu Product Code	Güç Power (W)	Işık Akışı Light Flux (lm)	Işık Kaynağı Light Source	Renk Sıcaklığı Color Temp.	Boyutlar Dimension (Ø/Hmm)	Kesim Ölçüsü Cut-Out Dimension (Ø/Hmm)	Ağırlık Weight (Kg)
VK019 102LED	1,2	150	POWER LED	3000-4000K	55X90	40X90	-



**IP 54**

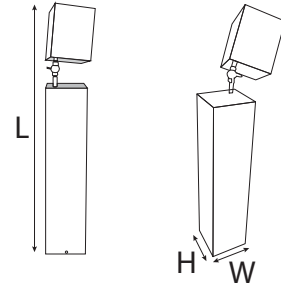

Ürün Kodu Product Code	Güç Power (W)	Işık Akışı Light Flux (lm)	Işık Kaynağı Light Source	Renk Sıcaklığı Color Temp.	Boyutlar Dimension (W/L/H)	Kesim Ölçüsü Cut-Out Dimension (W/L/Hmm)	Ağırlık Weight (Kg)
VK110 113LED	6	400	SMD LED	3000-4000K	120X750X120	-	-



**IP 54**

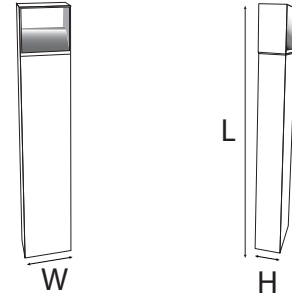
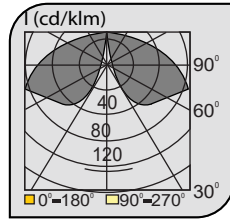

Ürün Kodu Product Code	Güç Power (W)	Işık Akışı Light Flux (lm)	Işık Kaynağı Light Source	Renk Sıcaklığı Color Temp.	Boyutlar Dimension (W/L/H mm)	Kesim Ölçüsü Cut-Out Dimension (W/L/H mm)	Ağırlık Weight (Kg)
VK110 112LED	2,5	250	SMD LED	3000-4000K	130X700X71	-	-



**IP 54**

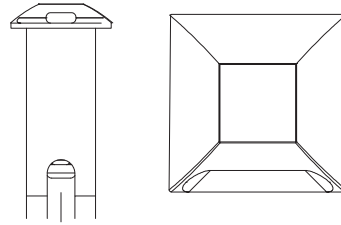

Ürün Kodu Product Code	Güç Power (W)	Işık Akışı Light Flux (lm)	Işık Kaynağı Light Source	Renk Sıcaklığı Color Temp.	Boyutlar Dimension (Ø/Hmm)	Kesim Ölçüsü Cut-Out Dimension (Ø/Hmm)	Ağırlık Weight (Kg)
VK600 081LED	2,5	250	SMD LED	3000-4000K	100X590	-	-
VK600 082LED	2,5	250	SMD LED	3000-4000K	100X590	-	-
VK600 084LED	2,5	250	SMD LED	3000-4000K	100X590	-	-



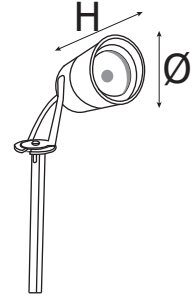

**IP 54**

Ürün Kodu Product Code	Güç Power (W)	Işık Akışı Light Flux (lm)	Işık Kaynağı Light Source	Renk Sıcaklığı Color Temp.	Boyutlar Dimension (Ø/Hmm)	Kesim Ölçüsü Cut-Out Dimension (Ø/Hmm)	Ağırlık Weight (Kg)
VK600 061LED	5	350	GU10	2700-3000-4000K	70X115	-	-



**IP 65**

Ürün Kodu Product Code	Güç Power (W)	Işık Akışı Light Flux (lm)	Işık Kaynağı Light Source	Renk Sıcaklığı Color Temp.	Boyutlar Dimension (Ø/Hmm)	Kesim Ölçüsü Cut-Out Dimension (Ø/Hmm)	Ağırlık Weight (Kg)
VK600 062LED	5	350	GU10	2700-3000-4000K	70X115	-	-

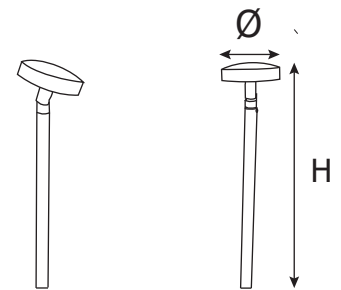
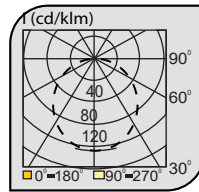

**IP 54**

Ürün Kodu Product Code	Güç Power (W)	Işık Akışı Light Flux (lm)	Işık Kaynağı Light Source	Renk Sıcaklığı Color Temp.	Boyutlar Dimension (Ø/Hmm)	Kesim Ölçüsü Cut-Out Dimension (Ø/Hmm)	Ağırlık Weight (Kg)
VK600 070LED	2,5	250	SMD LED	3000-4000K	100X590	-	-



**IP 65**

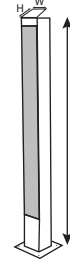

Ürün Kodu Product Code	Güç Power (W)	Işık Akışı Light Flux (lm)	Işık Kaynağı Light Source	Renk Sıcaklığı Color Temp.	Boyutlar Dimension (W/L/H)	Kesim Ölçüsü Cut-Out Dimension (W/L/Hmm)	Ağırlık Weight (Kg)
VK110 111LED	10	900	LED MODÜL	3000-6500K	85X300X80	-	-
VK110 112LED	20	1800	LED MODÜL	3000-6500K	85X600X80	-	-

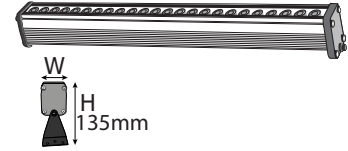
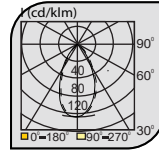
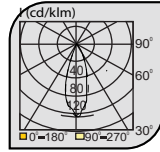
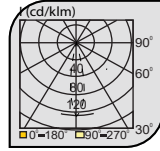

**IP 65**

Ürün Kodu Product Code	Güç Power (W)	Işık Akışı Light Flux (lm)	Işık Kaynağı Light Source	Renk Sıcaklığı Color Temp.	Boyutlar Dimension (W/L/H mm)	Kesim Ölçüsü Cut-Out Dimension (W/L/H mm)	Ağırlık Weight (Kg)
VK400 040LED	12	1680	POWER LED	3000-4000-6500K	55X360X75	-	-
VK400 050LED	18	2520	POWER LED	3000-4000-6500K	55X500X75	-	-
VK400 100LED	36	5040	POWER LED	3000-4000-6500K	55X1000X75	-	-



**IP 65**

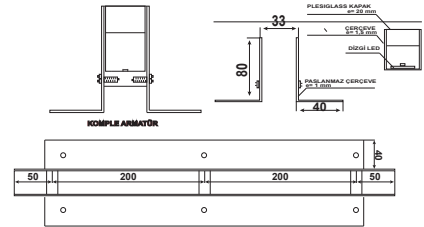

Ürün Kodu Product Code	Güç Power (W)	Işık Akışı Light Flux (lm)	Işık Kaynağı Light Source	Renk Sıcaklığı Color Temp.	Boyutlar Dimension (W/L/Hmm)	Kesim Ölçüsü Cut-Out Dimension (W/L/Hmm)	Ağırlık Weight (Kg)
VK172 100LED	7,5	750	SMD LED	3000-4000K	30X1000X80	-	-
VK172 200LED	15	1500	SMD LED	3000-4000K	30X2000X80	-	-

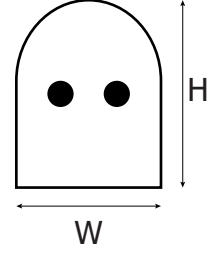
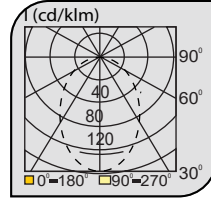

### IP 65

Ürün Kodu Product Code	Güç Power (W)	Işık Akışı Light Flux (lm)	Işık Kaynağı Light Source	Renk Sıcaklığı Color Temp.	Boyutlar Dimension (W/H mm)	Kesim Ölçüsü Cut-Out Dimension (W/H mm)	Ağırlık Weight (Kg)
VK001 024 DS	12	1000	SMD LED	2700-2900K	12X12	-	-
VK001 024 DB	12	1000	SMD LED	3500-4200K	12X12	-	-

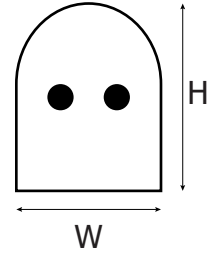
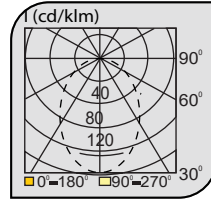

### IP 65

Ürün Kodu Product Code	Güç Power (W)	Işık Akışı Light Flux (lm)	Işık Kaynağı Light Source	Renk Sıcaklığı Color Temp.	Boyutlar Dimension (W/H mm)	Kesim Ölçüsü Cut-Out Dimension (W/H mm)	Ağırlık Weight (Kg)
VK001 024 YS	9	800	SMD LED	2700-2900K	8X17	-	-
VK001 024 YB	9	800	SMD LED	3500-4200K	8X17	-	-

